

#10(14) | 2018

СЕТЕВОЕ ИЗДАНИЕ | ISSN 2587-6791

МЕЖДУНАРОДНЫЙ НАУЧНО-ПРАКТИЧЕСКИЙ ЖУРНАЛ

SCIENCE

MODERN RESEARCHES

СОВРЕМЕННЫЕ  
ИССЛЕДОВАНИЯ

ЦНИК



ЦЕНТР  
НАУЧНЫХ  
ИССЛЕДОВАНИЙ  
И КОНСАЛТИНГА

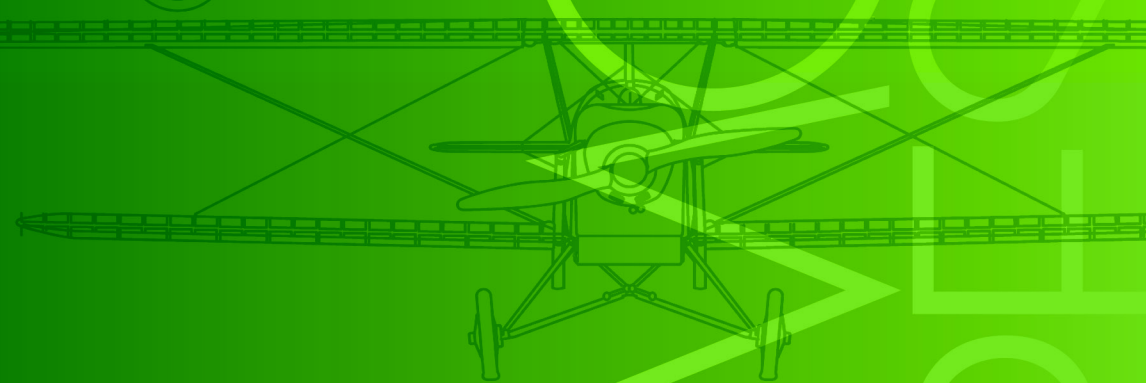

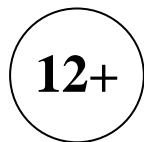

**ISSN 2587-6791**

# **СОВРЕМЕННЫЕ ИССЛЕДОВАНИЯ**

№ 10 (14) / 2018

1174, 373.1, 33, 336-161.1, 336.7, 331.56, 336-161.1, 336, 339.7, 2964, 336-161.1, 34, 343.274, 66.063, 004.41, 004.41, 658; 663; 664, 62-251, 159.9.072, 617-089.844, 617-089.844, 616-091.816

**10 (14) / 2018**

12

*Учредитель сетевого издания*

" " "

( )

• • ,

:

*Radek Novák, Mgr at Mgr*

( . , );

*A.B. Азархин, . . ,*

( . , );

*A.A. Ермошкин, . .*

( . , );

*M.Ю. Иванов, - . . ,*

( . , );

*Н.В. Мингалёв, . .*

( . , );

*Е.В. Фоменко, . . ,*

( . , );

*А.Д. Цой, . . ,*

( . , );

*М.В. Шингарева, . . ,*

( . , )

: *Р.О. Летфуллин*

. - 2018. - 10 (14). - 78 .

1174, 373.1, 33, 336-161.1, 336.7, 331.56, 336-161.1, 336, 339.7, 2964, 336-161.1, 34, 343.274, 66.063, 004.41, 004.41, 658; 663; 664, 62-251, 159.9.072, 617-089.844, 617-089.844, 616-091.816

(<http://elibrary.ru/>)

455-11/2017 14

2017 .

ISSN 2587-6791

©  
"

", 2018

## MODERN RESEARCHES

10 (14) / 2018

Scientific and Practical journal  
Online edition  
Monthly edition

*Founder*  
Limited Liability Company  
"Center of Scientific Researches and Consulting"

**Chief Editor**  
**(President of the Editorial Board)**  
**Yu.P. Grabozdin**, Candidate of Economics

### Editorial Board:

*Radek Novák*, Mgr at Mgr  
(Prague, the Czech Republic);

*A.V. Azarkhin*, Candidate of Economic Sciences  
(Samara, Russia);

*A.A. Ermoshkin*, Candidate of Engineering Sciences  
(Samara, Russia);

*M.Yu. Ivanov*, Dr. of Economics, Associate Professor  
(Samara, Russia);

*N.V. Mingalev*, Candidate of Economic Sciences  
(Samara, Russia);

*E.V. Fomenko*, Candidate of Economic Sciences,  
Associate Professor (Samara, Russia);

*A.D. Tsoi*, Candidate of Engineering Sciences,  
Associate Professor (Syzran, Russia);

*M.V. Shingareva*, Candidate of Pedagogic Sciences,  
Associate Professor (Samara, Russia)

**Executive Secretary:** *R.O. Letfullin*

**Modern researches.** - 2018. - 10 (14). - 78 p.

---

Full-text access to articles of the journal is available on the journal's website and on the website of the Scientific Electronic Library (<http://elibrary.ru/>) under contract No. 455-11 / 2017 of November 14, 2017.

# СОДЕРЖАНИЕ

---

... ..8

... ..12

... ..15

... ..18

... ..20

... ..22

... ..26

... ..28

... ..30

... ..33

... ..35

... ..37

... ..39

• ,	• ,	• .	43
• ,	• .		46
• ,	• .	-	48
А.А.,	• .	НАССР	51
• .			55
• ,	• .		58
• ,	• .		62
• ,	• .		67
• ,	• .		74

# CONTENTS

---

## *PEDAGOGICAL SCIENCES*

**VERETENNIKOVA E.N.**

The use of role-playing games in English lessons as a means of formation of educational and cognitive activity.....8

**ZHARKOVA A.E., ZOLOTOVA I.A.**

The projection of the reflexive approach in the preparation of quality lesson .....12

## *ECONOMIC SCIENCES*

**BRUSENTSEVA E.P., REPINA V.V.**

Analysis of development of the education services market in Samara Region.....15

**VETLUGINA T.V.**

History of cryptocurrency: from the prerequisites to the emergence to the present day .....18

**GALIULINA D.SH., LYSENKO YU.V.**

Real-time creatural course .....20

**DAVIDYUK K.G.**

Measures to combat youth unemployment in Russia .....22

**DURASHKINA A.V.**

History of development of cryptocurrency in Russia .....26

**KRIVONOSOVA O.O.**

Reasons for slow-dependent legalization of cryptowriters.....28

**LYSENKO YU.V., ADISHEVA V.E.**

The story of the cryptocurrency .....30

**LYSENKO YU.V., PONOMAREVA E.V.**

Leading corporations in the field of digital technologies .....33

**SHATUNOVA V.A.**

Digital technologies as business development factor .....35

## *JURISPRUDENCE*

**TITOVA A.V.**

The ratio of Russian and foreign legal positions for violations copyright .....37

**SHAMIEVA YA.V.**

Forced labour in comparison with some other types of punishments .....39

**TECHNICAL SCIENCES**

**GOLOVANCHIKOV A.B., CHYORIKOVA K.V., KINGIBAEVA T.S.**  
A study of the mixing process in the apparatus using the combined mixers ..... 43

**ZUEVA A.S., LEONOV YU.A.**  
Designing of object model for informational analytical system monitoring module ..... 46

**ZUEVA A.S., LEONOV YU.A.**  
Developing of functional diagram of monitoring module for mobile applications stores ..... 48

**KARAPETYAN A.A., BATIKYAN H.G.**  
Risk analysis in the implementation of the HACCP system at public catering ..... 51

**KONNOV I.V.**  
Calculation of the strength of rotating disks by the method of finite differences ..... 55

**NORKINA F.R., SOLOVYANUK L.G.**  
Comparative analysis of program complexes psychodiagnostics of the identity  
of the school student..... 58

**MEDICAL SCIENCES**

**BEREGOVENKO D.A., GOROVA A.YU.**  
The Mirizzi syndrome. Surgical treatment..... 62

**BEREGOVENKO D.A., MIKHALCHUK M.S.**  
Surgical treatment of megaureter ..... 67

**ZVERKO N.L., ASKAROVA V.R.**  
Role of human papillomavirus in the development of squamous cell laryngeal cancer ..... 74







),

“Intruders”.

: “A man arrives to repair a woman’s TV set. He completes the job, and while doing so, settles down to lives in the room” [4].

1-2

[6].

[6]

[3]

(

1. ... // ... 2010. - 1. - . 34 - 38.
2. ... / ... . - .: ... , 1988. - 169 .
3. ... / Т. ... // ... - 2005. - 1. - С. 21-23/
4. Maley A. Technique in Language Learning / A. Maley, A. Duff - Cambridge University Press, 1978. - 140 p.
5. Oller J.W. Methodshat Work / J.W. Oller - Boston: Heinle and Heinle Publishers, 1993. - 197 p.
6. ... - 2014. - 7. - . 527-529. - URL <https://moluch.ru/archive/66/11095/> ( : 06.10.2018)

*Статья поступила в редакцию 10.10.2018 г.*

*Статья рекомендована к публикации 13.10.2018 г.*

© E.N. Veretennikova, 2018

### **THE USE OF ROLE-PLAYING GAMES IN ENGLISH LESSONS AS A MEANS OF FORMATION OF EDUCATIONAL AND COGNITIVE ACTIVITY**

This article is devoted to the theoretical basements and practical use of role-play method in the process of learning English. A number of role-playing games of various authors are noted.

**Keywords:** role-play, method, functions, lesson.

*Received for edition on 10.10.2018*

*Recommended for publication on 13.10.2018*

© . . . , 2018

студент

ФГБОУ ВО "ЮУрГГПУ"

© . . . , 2018

Зам. директора по учебно-методической работе

ГБОУ ЧКШИ с ПЛП

г. Челябинск, Россия

( ) .

[4].

[2],

(5-9 ) .

[5]:

<p>1. ;</p> <p>2. ;</p> <p>3. ;</p>	<p>1. ;</p> <p>2. , ; -</p> <p>3. , ; -</p> <p>.( "</p> <p>?, " -</p> <p>?, " ?"</p> <p>. .)</p>
-------------------------------------	--

1. [1]

2. [2]. 4 [5].

3. ( , . .),

1. . . // . . . - 2017. - 4. - .49-54;

2. . . : // . . . - 2015. - 3(63). - .3. - .26-29;

- 
3. . . // . . .  
- 2014. - 5. - . 66-70;  
4. . . // . . . ,  
- 2012. - 2. - .2. - 210-214;  
5. . . // . . . -  
2016. - 4-2 (4). - . 133-135.

*Статья поступила в редакцию 18.10.2018 г.  
Статья рекомендована к публикации 21.10.2018 г.*

© А.Е. Zharkova, I.A. Zolotova, 2018

### THE PROJECTION OF THE REFLEXIVE APPROACH IN THE PREPARATION OF QUALITY LESSON

The article deals with the introduction of a reflexive approach to the educational process. Reflection becomes the main criterion of quality of technologies which develop the personality of the student that is caused by introduction of Federal state educational standard.

**Keywords:** critical thinking, educational process, reflection, reflexive approach, Federal state educational standard.

*Received for edition on 18.10.2018  
Recommended for publication on 21.10.2018*

© . . . , 2018

студент

© . . . , 2018

студент

. . .  
 к.э.н., доцент кафедры экономики  
 ФГБОУ ВО "Самарский государственный  
 социально-педагогический университет"  
 г. Самара, Россия



... , -  
 , -  
 . -  
 " -  
 "5-100", , -  
 ( ). -  
 , -  
 : , -  
 1) ( ) ; -  
 2) " "; -  
 3) ; -  
 4) ; -  
 5) . -  
 " " -  
 , " ". -  
 : , -  
 1) ; -  
 2) ; -  
 3) . -  
 , -  
 , -  
 , -

- 1) ;
- 2) ;
- 3) .
1. : - ., 2002. - . 351.
  2. : - ., 1998. - . 305.
  3. <https://www.educat.samregion.ru/>.
  4. <https://www.kommersant.ru/doc/3080604>.
  5. <http://volga.news/article/359035.html>.
  6. [http://www.samara.aif.ru/society/details/samarskie\\_universitety\\_voshli\\_v\\_sписок\\_luchshih\\_vuzov\\_strany](http://www.samara.aif.ru/society/details/samarskie_universitety_voshli_v_sписок_luchshih_vuzov_strany).

*Статья поступила в редакцию 12.10.2018 г.*

*Статья рекомендована к публикации 15.10.2018 г.*

© **E.P. Brusentseva, V.V. Repina, 2018**  
*Research supervisor*  
**Yu.P. Grabozdin**

## ANALYSIS OF DEVELOPMENT OF THE EDUCATION SERVICES MARKET IN SAMARA REGION

The article deals with the features of the education services market in Samara region on the example of higher and secondary educational institutions. The analysis of problems of development of the education services market is carried out and ways of the solution of the revealed problems are offered.

**Keywords:** education service, education services market, educational institutions, education system.

*Received for edition on 12.10.2018*

*Recommended for publication on 15.10.2018*





Рис.

2016 .

2018 [1]

1. Forex club [ ] : . URL:  
<https://www.fxclub.org/markets/crypto/bitcoin/> ( 10.10.2018).
2. , , , 2017. - 32. - . 61-64. //
3. , 2016. - 11-2. - . 177-179. //

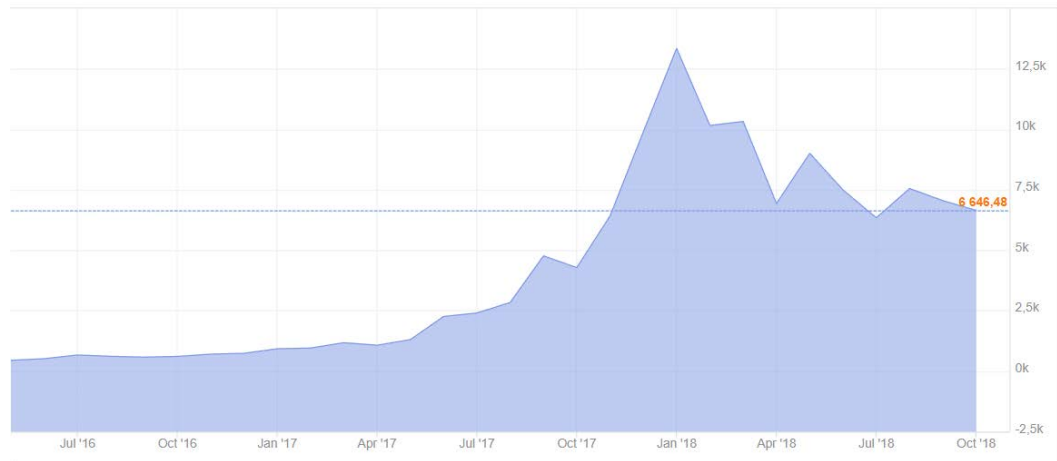
*Статья поступила в редакцию 13.10.2018 г.  
 Статья рекомендована к публикации 16.10.2018 г.*

© T.V. Vetlugina, 2018  
 Research supervisor  
 Yu.V. Lysenko

### HISTORY OF CRYPTOCURRENCY: FROM THE PREREQUISITES TO THE EMERGENCE TO THE PRESENT DAY

The article deals with the history of the cryptocurrency, its promotion in the financial market, as well as the prospects for the development of cryptocurrencies in the future.

**Keywords:** cryptocurrency, bitcoin, financial market.

*Received for edition on 13.10.2018  
 Recommended for publication on 16.10.2018*

© . . . , 2018  
студент 5 курса физико-математического факультета  
© . . . , 2018  
д. э. н., профессор кафедры экономики, управления и права  
ЮУрГГПУ  
г. Челябинск, Россия

2014-2018 .

2008  
2017  
300  
[1].  
2013 . 2017 . ( . 1) [2].



Рис. 1. 2013 - 2017 .

2014  
2015  
\$370  
2016  
80%  
30  
2016 .  
1000\$ [3].  
\$50,  
600\$,

2017 2900\$.  
17 000 -  
2018 , 10

7 000

( . 2,3,4).

[2].



Рис. 2.

2015



Рис. 3.

2016



Рис. 4.

2017

6639\$.

4

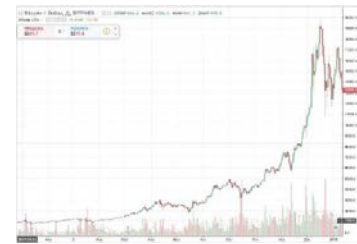
9863 \$.

2018

6497\$

2018 .,

1.

" , " , 2017. - . 354.

2.

. [ ]: <https://ru.investing.com/crypto/>.

3.

2018 : ? [ ]: <https://youcrypt.ru/kriptoalyuta-v-2018-godu-stoit-li-vkladvatysya/>.

*Статья поступила в редакцию 14.10.2018 г.*

*Статья рекомендована к публикации 17.10.2018 г.*

© D.Sh. Galiulina, Yu.V. Lysenko, 2018

### REAL-TIME CREATURAL COURSE

The article presents an analysis of the cryptocurrency rate for the period 2014-2018.

**Keywords:** Cryptocurrency, cryptocurrency rate, Bitcoin.

*Received for edition on 14.10.2018*

*Recommended for publication on 17.10.2018*



- 1) ; ( ), -
- 2) ( ), ( -  
). , -  
.
- 3) ; - -  
, -  
( ) . , -  
, , , -  
, , .
- 1) , , - , .  
;
- 2) - , - , -  
, ;
- 3) - , , -  
, , -  
;
- 4) , , - , ,  
, , , -  
, ;
- 5) - , , -  
, , -
- 6) О - , , -



1)

2)

. [2]

1)

2)

20

200

3

. [3]

1.	2.	3.	4.	5.	6.	7.	8.	9.	10.	11.	12.	13.	14.	15.	16.	17.	18.	19.	20.	21.	22.	23.	24.	25.	26.	27.	28.	29.	30.	31.	32.	33.	34.	35.	36.	37.	38.	39.	40.	41.	42.	43.	44.	45.	46.	47.	48.	49.	50.	51.	52.	53.	54.	55.	56.	57.	58.	59.	60.	61.	62.	63.	64.	65.	66.	67.	68.	69.	70.	71.	72.	73.	74.	75.	76.	77.	78.	79.	80.	81.	82.	83.	84.	85.	86.	87.	88.	89.	90.	91.	92.	93.	94.	95.	96.	97.	98.	99.	100.
----	----	----	----	----	----	----	----	----	-----	-----	-----	-----	-----	-----	-----	-----	-----	-----	-----	-----	-----	-----	-----	-----	-----	-----	-----	-----	-----	-----	-----	-----	-----	-----	-----	-----	-----	-----	-----	-----	-----	-----	-----	-----	-----	-----	-----	-----	-----	-----	-----	-----	-----	-----	-----	-----	-----	-----	-----	-----	-----	-----	-----	-----	-----	-----	-----	-----	-----	-----	-----	-----	-----	-----	-----	-----	-----	-----	-----	-----	-----	-----	-----	-----	-----	-----	-----	-----	-----	-----	-----	-----	-----	-----	-----	-----	-----	-----	------

1. . . . . - .: . . . . -4- . . . . ., 2011.- .346-349.
2. <http://www.study-economics.ru>.
3. <http://government.ru>.

*Статья поступила в редакцию 22.10.2018 г.  
Статья рекомендована к публикации 25.10.2018 г.*

© K.G. Davidyuk, 2018  
*Research supervisor*  
Ya.V. Mochalova

## MEASURES TO COMBAT YOUTH UNEMPLOYMENT IN RUSSIA

This article discusses measures to combat unemployment among young people in Russia, as it remains one of the most acute problems in the field of labor. The causes of this phenomenon and its types are identified, along with the ways to provide effective assistance to young people who have difficulties with employment. This problem is very urgent and requires an early solution, because young people currently make up about 35% of the working-age population of Russia and is the future of our country.

**Keywords:** youth, youth unemployment, natural unemployment rate, labour market, employability.

*Received for edition on 22.10.2018  
Recommended for publication on 25.10.2018*

© . . . , 2018

бакалавр 5 курса физико-математического факультета

. . .

д.э.н., профессор кафедры экономики, управления и права

ЮУрГГПУ

г. Челябинск, Россия

18 : , blockchain, .

2015 blockchain. -

blockchain ( - ), -

[1]. ,

," " . -

," . -

," 1 2018 -

2018 " -

2018 " " " -

," -

," -

1. [URL: <https://www.minfin.ru/ru/document/> (14.10.2018).
2. "
3. [URL: <https://iz.ru/> (15.10.2018).

*Статья поступила в редакцию 21.10.2018 г.  
Статья рекомендована к публикации 24.10.2018 г.*

© **A.V. Durashkina, 2018**  
**Research supervisor**  
**Yu.V. Lysenko**

## **HISTORY OF DEVELOPMENT OF CRYPTOCURRENCY IN RUSSIA**

The main stages of formation of cryptocurrency in Russia are presented. Legal conditions in the sphere of development of cryptocurrency in the Russian Federation are considered.

**Keywords:** cryptocurrency, tokens, blockchain, mining, digital financial assets.

*Received for edition on 21.10.2018  
Recommended for publication on 24.10.2018*

© . . . , 2018

бакалавр 5 курса физико-математического факультета

. . .

д.э.н., профессор кафедры экономики, управления и права

ЮУрГГПУ

г. Челябинск, Россия

Год	Средняя стоимость транзакции, руб.	Средняя стоимость транзакции, доллар	Средняя стоимость транзакции, евро
2018	650 000	850 000	500

1. . Tech [ ] :  
URL: <https://cryptocurrency.tech/kak-vyzhit-kriptobirzham-v-epohu-regulirovaniya/>.

2. Binbroker [ ] URL:  
<https://binbroker.ru/stati-o-kriptovalyutah/173-est-li-budushee-u-kriptovalyuty-i-v-chem-ee-preimuschestva.html>.

*Статья поступила в редакцию 21.10.2018 г.  
Статья рекомендована к публикации 24.10.2018 г.*

© O.O. Krivonosova, 2018  
*Research supervisor*  
Yu.V. Lysenko

## REASONS FOR SLOW-DEPENDENT LEGALIZATION OF CRYPTOWRITERS

The article presents the reasons for the slow legalization of alternative currencies, and also considers the policies of several countries on the issue of legalization of cryptocurrencies.

**Keywords:** cryptocurrency, legalization of cryptocurrency, Bitcoin.

*Received for edition on 21.10.2018  
Recommended for publication on 24.10.2018*

© . . . , 2018

доктор экономических наук, профессор

© . . . , 2018

студент 5 курса физико-математического факультета

ФГБОУ ВО "Южно-Уральский государственный

гуманитарно-педагогический университет"

г. Челябинск, Россия

Bitcoin.

: , , .

. , , .

( , ( , ) , XXI

" . "

( . kryptos - ) - ( , ) [3].

[1]

Intel. 1992 . , PGP-

" [2].

Intel - "

1998 . B-money.

- [2].





## THE STORY OF THE CRYPTOCURRENCY

In this article discusses the history of the concept of cryptocurrency and cryptographic systems before the advent of Bitcoin.

**Keywords:** digital currency, cryptocurrency, bitcoin.

*Received for edition on 22.10.2018*

*Recommended for publication on 25.10.2018*

© . . . , 2018  
 доктор экономических наук,  
 профессор кафедры экономики, управления и права  
 © . . . , 2018  
 студент  
 ФГБОУ ВО "Южно - Уральский государственный  
 гуманитарно - педагогический университет"  
 г. Челябинск, Россия

1. Apple, Inc., -

, 1976

Apple

2. Google Inc. -

2 2015 .

Alphabet,

. Google



УДК 336-161.1

© . . . , 2018  
бакалавр 5 курса физико-математического факультета

. . .  
д.э.н., профессор кафедры экономики,  
управления и права  
ЮУрГГПУ  
г. Челябинск, Россия

[2].

( 30%),

( )

1. // , 10  
2017 " " 61.  
2. [ ] : URL: <https://www.sap.com> (  
14.10.2018).  
3. : // -  
4. , . , . . . . . : -  
, 2018-340 .

*Статья поступила в редакцию 24.10.2018 г.  
Статья рекомендована к публикации 27.10.2018 г.*

© V.A. Shatunova, 2018  
*Research supervisor*  
Yu.V. Lysenko

## DIGITAL TECHNOLOGIES AS BUSINESS DEVELOPMENT FACTOR

This article discusses the impact of the present or absence of digital technologies in business. On the basis of numerous experiments, the main directions of introducing digital technologies are given.

**Keywords:** business, development, digital technologies, competitiveness.

*Received for edition on 24.10.2018  
Recommended for publication on 27.10.2018*

УДК 34

© . . . , 2018

магистр

ФГБОУ ВО "СГЮА"

г. Саратов, Россия

,  
 -  
 -  
 : , .  
 , ,  
 , ,  
 ( " ").  
 , 1988 .  
 - ,  
 , " ,  
 , , ( -  
 ), [1].  
 :  
 1. , .  
 2. .  
 3. , -  
 , [2].  
 , ,  
 , ,  
 , .  
 ,  
 .5 .1250 ,  
 .1252), ( .5 .1  
 ( .2 .1 .1252),  
 ( .4 .1 .1252).

... ( .3 .1 .1252 ),  
 ( .3 .1252, .1301 ).

...  
 ...  
 ... .4 .1250 ...  
 ... .3 4 .1 .3 .1252 ...  
 ... 20 ...  
 2012 . N 8953/12 N 40-82533/11-12-680 ...  
 " " - "[3].  
 " " ,  
 " " ,  
 " " ,  
 " " ,  
 " " ,  
 " " .3 .1250 .

1. / . . . . , . . . . -  
 . . . . , 2005. . II. . 477 - 478.
2. Bently L., Sherman B. Intellectual Property Law. P. 217, 218.
3. 40-82533/2011 // . URL: <http://kad.arbitr.ru/Card/568e8192-4d0d-4f68-b7b0-a947b40ee8c9> ( : 03.10.2018).

*Статья поступила в редакцию 06.10.2018 г.  
 Статья рекомендована к публикации 09.10.2018 г.*

© A.V. Titova, 2018

### THE RATIO OF RUSSIAN AND FOREIGN LEGAL POSITIONS FOR VIOLATIONS COPYRIGHT

In the article describes the differences in the view of copyright infringement in the system of common and continental law and concludes on the possibility of innocent liability in Russian law.

**Keywords:** copyright, continental law.

*Received for edition on 06.10.2018  
 Recommended for publication on 09.10.2018*





[4].

. 43

. 2

" " " " [5].

" [3].

[5].

[5].

II  
" [2]



1. " [ ]:  
13.06.1996 63- ( . 29.07.2018). - "
2. " [ ]:  
08.01.1997 1- ( . 20.12.2017). - "
3. :  
// . 2016. 1 (36). . 63-66.
4. // . 2015.  
1 (26). . 95-101.
5. :  
. 2016. 15. . 94-98.  
// -
6. // -  
. 2014. 4. . 197-202.

*Статья поступила в редакцию 10.10.2018 г.  
Статья рекомендована к публикации 13.10.2018 г.*

© Ya.V. Shamieva, 2018

### **FORCED LABOUR IN COMPARISON WITH SOME OTHER TYPES OF PUNISHMENTS**

The article deals with forced labour in comparison with corrective labour, compulsory labour and imprisonment in a penal colony settlement. Similarities and differences of the above mentioned types of punishments are distinguished.

**Keywords:** forced labour, compulsory labour, corrective labour, imprisonment in a penal colony settlement.

*Received for edition on 10.10.2018  
Recommended for publication on 13.10.2018*

© . . . , 2018

д.т.н., профессор кафедры ПАХПП

© . . . , 2018

старший преподаватель кафедры ПАХПП

© . . . , 2018

бакалавр 3 курса факультета технологии пищевых производств

Волгоградский государственный технический университет

г. Волгоград, России

[1].

ES-8300D,

6:1 [1-2].

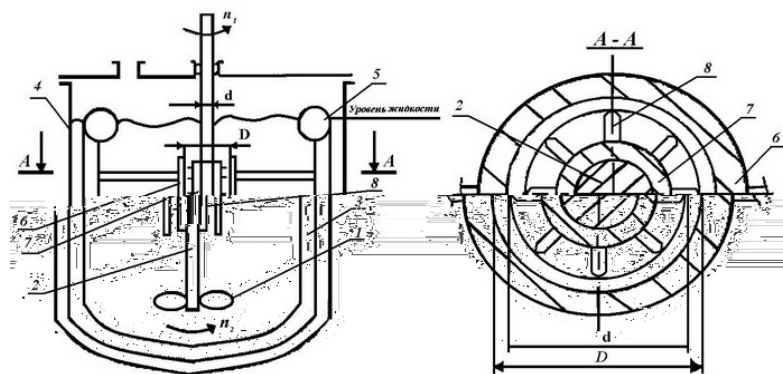

1 - ; 2 - ; 3 - ; 4 - ;  
5 - ; 6 - ; 7 - ;  
8 -

Рис. ( . . . 152750 , 2015 . ) [3]

... , -

" - ", , , -

... [4].

$\omega = k \cdot \omega^n$  [4]:

:

$\omega = 0,0053 \cdot \omega^{1,325}$ , (1)

:

$\omega = 0,0047 \cdot \omega^{1,348}$ , (2)

(1)

$F_p = 9,3519$ ,  $F_p = 2,66$ .

(2)

$F_p = 2,21 < 2,66$ .

$a$   $b$   $a$

$b$  ,  $S_a=331,4$   $S_b=83,283$   $St^{tab}=2,14$ .

$r=0,9944$ .

1. , ... -

/ ... , ... // -

: . - 2016. - 2 (14). - С. 11-14.

2. / ... ;

... , 1976. - 184 .

3. . . 152750 , 01 F 7/16. / . . , . . . ,

... ;

. - 2015100372/05; . 12.01.2015; . 20.06.2015.

4. : .

.1/ . . , . . . - . - 1994. - 114 .

*Статья поступила в редакцию 20.10.2018 г.  
Статья рекомендована к публикации 23.10.2018 г.*

## A STUDY OF THE MIXING PROCESS IN THE APPARATUS USING THE COMBINED MIXERS

The article discusses the results of experimental studies of the dependence of the number of revolutions of the low-speed frame agitator on the number of revolutions of the high-speed propeller agitator. The analysis of the obtained dependences allows to estimate the adequacy of the obtained mathematical model by the least squares method.

**Keywords:** mixing, mixing device, suspension, correlation, combined stirrer.

*Received for edition on 20.10.2018*

*Recommended for publication on 23.10.2018*

© . . . , 2018  
студент 4-ого курса, ФИТ

© . . . , 2018  
к.т.н., доцент

ФГБОУ ВО "Брянский государственный  
технический университет"  
г. Брянск, Россия

web- ( . ) .



Рис.

: WebPageLoader GooglePlay\_WebPageLoader, DomParser GooglePlay\_DomParser.

Google Play).  
[1].  
[1].  
WebPageLoader web-  
LoadWebPage, WebPageLoader web-  
, web- HTTP-  
( web- ),  
DomParser  
DOM- DOM-  
;

1. , . . . : /  
. . . . . : , 2016. - 208 .

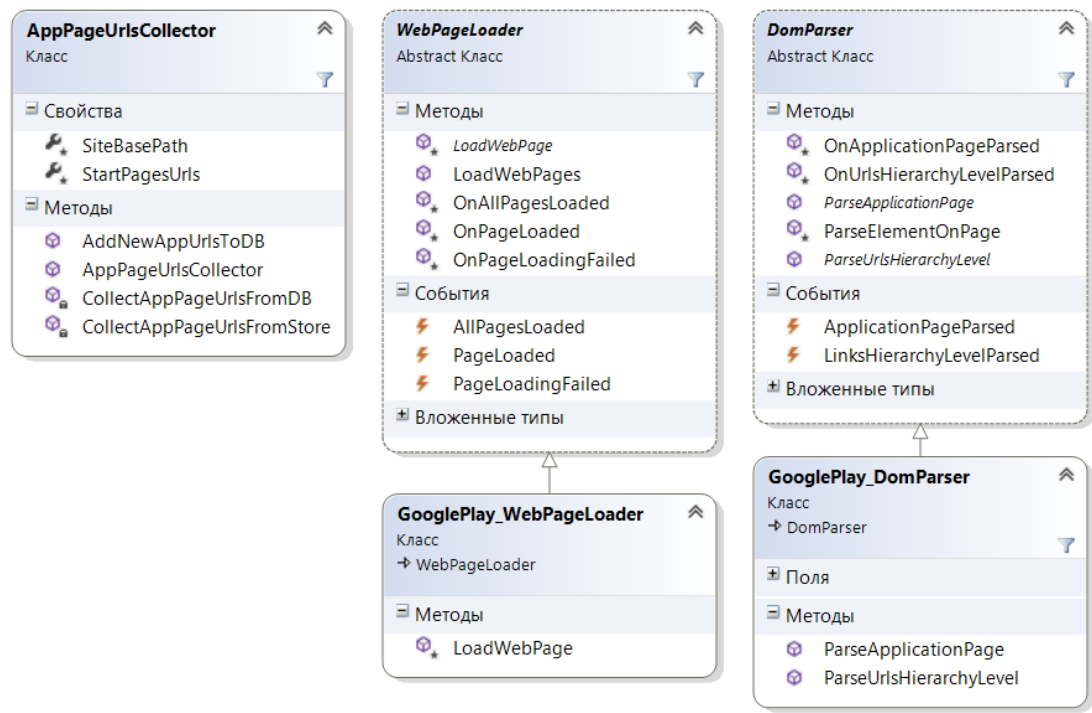
*Статья поступила в редакцию 12.10.2018 г.  
Статья рекомендована к публикации 15.10.2018 г.*

© A.S. Zueva, Yu.A. Leonov, 2018

**DESIGNING OF OBJECT MODEL FOR INFORMATIONAL  
ANALYTICAL SYSTEM MONITORING MODULE**



© . . . , 2018  
студент 4-ого курса, ФИТ

© . . . , 2018  
к.т.н., доцент  
ФГБОУ ВО "Брянский государственный  
технический университет"  
г. Брянск, Россия

...

2017 60 70

( ) [1].

web-

( ) IDEF0.

Framework, JSON.

API (Application Programming Interface)

GET- DOM- web-

NET

GET- CSS HTML. DOM-



Рис.

; С#

1. . . . . " . . . . .", 2013. - 384 .

Статья поступила в редакцию 12.10.2018 г.  
Статья рекомендована к публикации 15.10.2018 г.

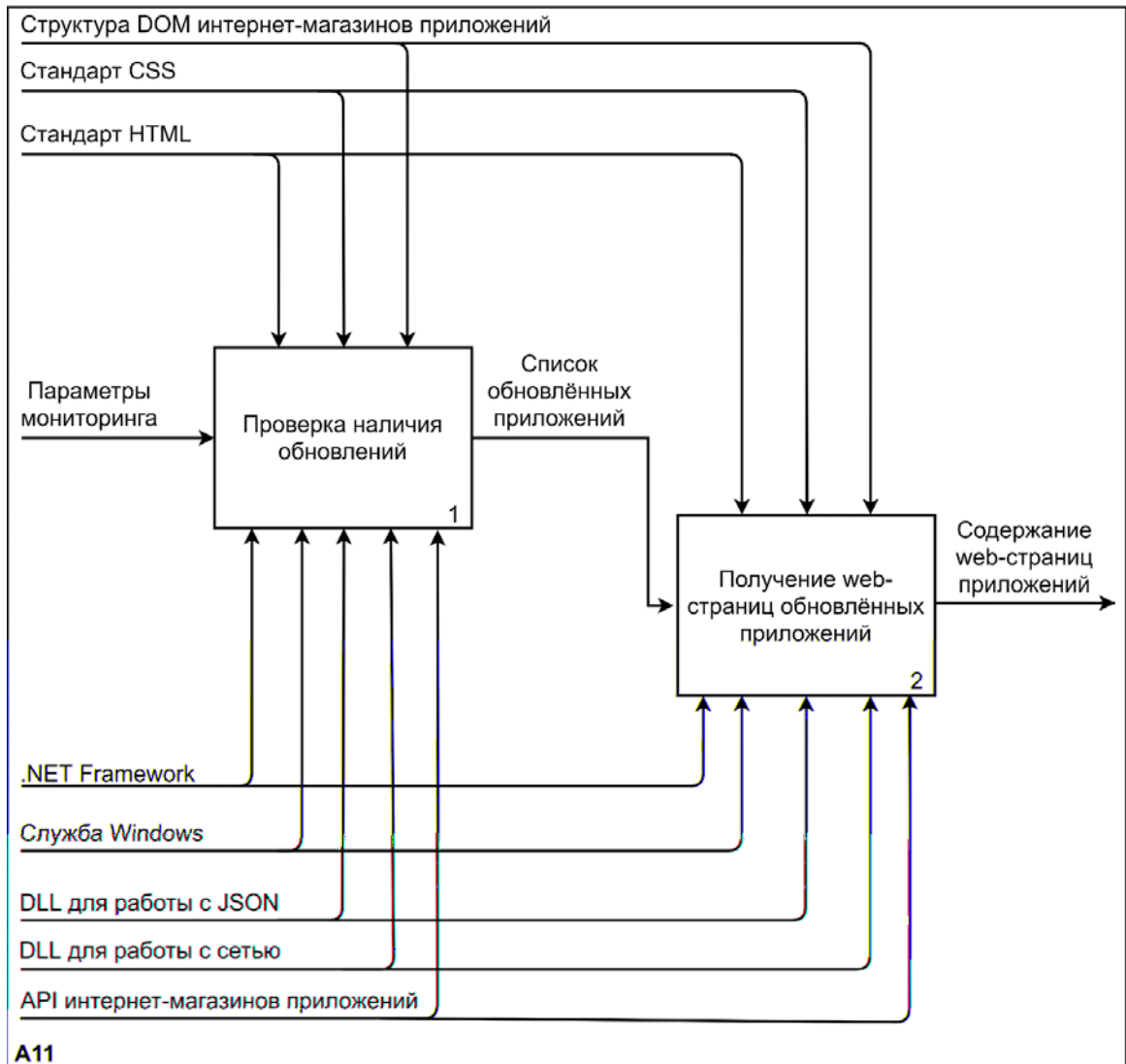
**DEVELOPING OF FUNCTIONAL DIAGRAM OF MONITORING MODULE  
FOR MOBILE APPLICATIONS STORES**

Necessity of Informational Analytical System development is substantiated in the article. The functions of the monitoring module are described. Monitoring module functional diagram is demonstrated.

**Keywords:** Informational Analytical System, IAS, monitoring module, functional diagram, market analysis, mobile applications.

*Received for edition on 12.10.2018*

*Recommended for publication on 15.10.2018*

УДК 658; 663; 664

© А.А. , 2018

кандидат технических наук,  
руководитель систем менеджмента  
качества и пищевой безопасности  
ООО "Фуд Продактс"  
г. Находка, Россия

© . . . , 2018

доктор биологических наук,  
академик инженерной академии Армении,  
директор учебного центра национального  
института метрологии  
г. Ереван, Республика Армения

### НАССР

Analysis and Critical Control Points)- (Hazard -

...

НАССР,

НАССР,

( ), ( ).

...

...

...

...

...

...

...

( ), ( ) 021/2011,

[5].

...

[1; 3; 7; 8].



(IFC)

[2; 6], ( . ).

	<b>A</b>				
	<b>B</b>				
	<b>C</b>				
	<b>D</b>				
	<b>E</b>				
		<b>1</b>	<b>2</b>	<b>3</b>	<b>4</b>
		<b>&lt;1</b>	<b>1</b>	<b>1</b>	<b>1</b>
		<b>2</b>		<b>6</b>	

Рис.

- 5 :
1. - 2 ;
  2. - ,
  3. - 6 ,
  4. - ,
  5. - .
- :
- A. - ,
  - B. - ,
  - C. - ,
  - D. - ,
  - E. - .

[2].

HACCP,

1. ... // ... 1 (135), ..., 2017.
2. ... // ... IFC ... , 2014.
3. ... LXIV " - ... 11 (59), ..., 2016.
4. Pest-Control // " - ... 4 (3), ..., 2017.
5. 021/2011 // ... , 2011.
6. ... // ... , 2015.
7. ... // " ... 6, 2014.
8. Batikyan H.G. HACCP system perspective in Armenia // The 1-st Regional Conferance of Quality and Integrated Managemant systems, in the Mediterranean and Gulf countrils, Lebanon, 2001.

*Статья поступила в редакцию 20.10.2018 г.  
Статья рекомендована к публикации 23.10.2018 г.*

© A.A. Karapetyan, H.G. Batikyan, 2018

### RISK ANALYSIS IN THE IMPLEMENTATION OF THE HACCP SYSTEM AT PUBLIC CATERING

Numerous studies have proven the effectiveness of HACCP (Hazard Analysis and Critical Control Points). In a number of public catering enterprises we have introduced risk management systems according to the HACCP model. Risk analyzes and assessments of the effectiveness of the implemented systems were carried out. Based on the studies conducted, it is proposed to ensure the safety of catering products under the HACCP Code based on the hazard assessment methodology specified in this publication.

**Keywords:** HACCP system, risk analysis, hazard factor, critical control points (CCP), critical limit (CL).

*Received for edition on 20.10.2018  
Recommended for publication on 23.10.2018*

© . . . , 2018

магистрант

ФГАОУ ВО "Самарский национальный  
исследовательский университет имени академика С.П. Королёва"

г. Самара, Россия

( . 1),

$\sigma_\varphi$

$\sigma_r$



Рис. 1.



$r_n$   $b_n$ .

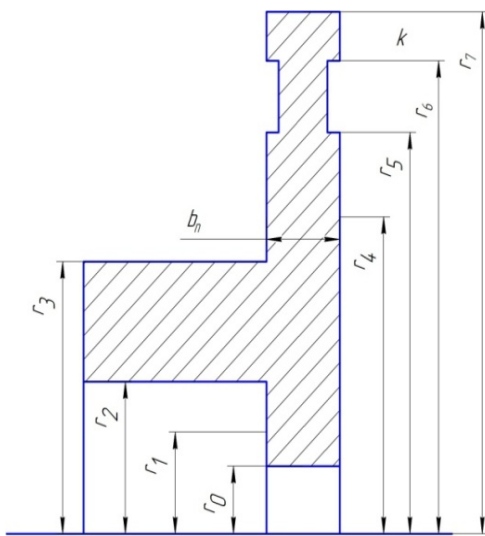
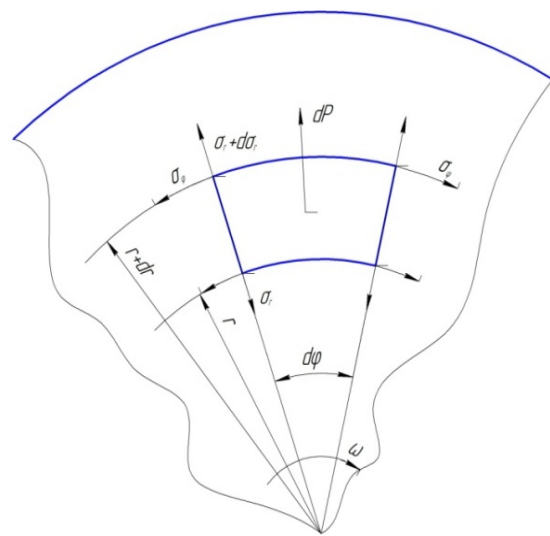

k,

$$\sigma = \sqrt{\sigma_r^2 + \sigma_\varphi^2 - \sigma_r \cdot \sigma_\varphi}$$

30

4543-71

750 /  
( 2)



Рис. 2.

1. - <http://storage.mstuca.ru/bitstream>

- 10.12.2018 .

Статья поступила в редакцию 22.10.2018 г.  
Статья рекомендована к публикации 25.10.2018 г.

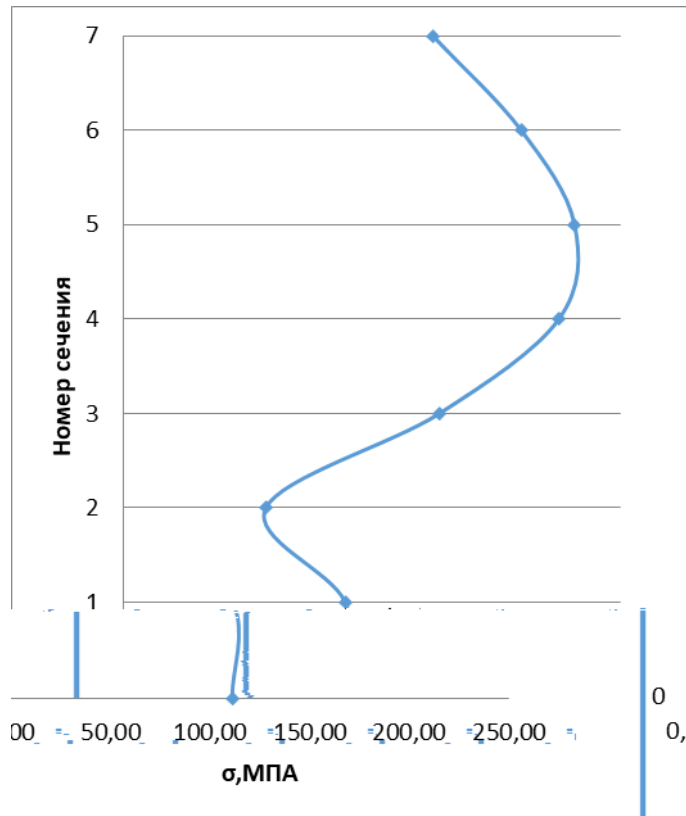
## CALCULATION OF THE STRENGTH OF ROTATING DISKS BY THE METHOD OF FINITE DIFFERENCES

This article presents a method for calculating the strength of turbomachine discs with adaptations and changes that allow using this method to calculate rotating discs that are not affected by the temperature gradient . An example is given of calculation for a disk of a complex shape.

**Keywords:** endurance, strain, calculations.

*Received for edition on 22.10.2018*

*Recommended for publication on 25.10.2018*

© . . . , 2018

магистрант

© . . . , 2018

к.п.н., доцент кафедры Прикладной информатики

ФГБОУ ВО Башкирский государственный

педагогический университет им. М. Акмуллы

г. Уфа, Россия

) " ";  
) - " ";  
) " (23 );  
) 1 :

	1 :	" "	" "	" "
-	+	+	-	-
	+	-	-	-
	50		23	20
	+	-	-	+
	+	+	+	-
	+	+	+	-
	+	-	-	-
	+	-	-	-
	+	-	-	-
	34600	6200	5000	26000

1 : " " -  
" " -  
( ) , -  
:  
• ;  
• ;  
• ( );  
• ;  
• -  
• ;  
• ;  
• ;  
• ;  
• -  
, " " , -  
, " " , -  
"1 : " 50  
, , :  
• ;  
• ;  
• ;  
• - - "1 : " :  
1)  
2)  
3)  
4)  
5)  
6)  
7)  
8)  
9)

- 50 , :
- ;
  - ( - , , )
  - ;
  - - ;
  - - ;
  - - ;
  - ;
  - .

#### Список литературы

1. " ". [ ]. URL: <http://www.imaton.com/metodiki/catalog>.
2. - " ". [ ]. URL: <http://www.sib-analitic.narod.ru/info/price120.htm>.
3. " ". [ ]. URL: <http://www.sib-analitic.narod.ru/info/price119.htm>.
4. 1 : . [ ]. URL: <http://solutions.1c.ru/catalog/psy/features>.

*Статья поступила в редакцию 20.10.2018 г.  
Статья рекомендована к публикации 23.10.2018 г.*

© F.R. Norkina, L.G. Solovyanuk, 2018

### COMPARATIVE ANALYSIS OF PROGRAM COMPLEXES PSYCHODIAGNOSTICS OF THE IDENTITY OF THE SCHOOL STUDENT

This article is devoted to the review of program complexes of psychodiagnostics of the identity of the school student.

**Keywords:** psychodiagnostics, psychological testing, technique, software, designer of tests.

*Received for edition on 20.10.2018  
Recommended for publication on 23.10.2018*







14% [12].

IV

1. ... [8]. 4

- 1 - ;
- 2 - - ;
- 3 - : - ;
- 4 - : - [16].

II , ... I

III

IV

1. ... : .2014. .132 .

2. ... ( .2014, .- .40

3. / ... , A.B. // .-2014.- .2.- .130-137.

4. " " / C . ! O A

- . - 2014. - . 127-128.
5. Ahlawat, S. K. Mirizzi syndrome / S. K. Ahlawat, R. Singhania, F. H. Al-Kawas // Curr. Treat. Options. Gastroenterol. - 2014. - Vol. 10, 2. - P. 102-110.
6. Diana Kaya MRCP diagnosis of Mirizzi syndrome in a paediatric patient: importance of TL-weighted gradient echo images for diagnosis / Kaya Diana, Karcaaltincaba Musturay // Pediatr. Radiol. - 2014. - Vol. 36. - P. 980- 982
7. Chang-Hwan, P. Endoscopic Retrograde Cholangiopancreatography in Post Gastrectomy Patients / P. Chang-Hwan // Clin Endosc. - 2016. - Vol. 49. - P. 506-509.
8. Gomez D. Mirizzi's syndrome - results from a large western experience / D. Gomez, S.H. Rahman // HPB. - 2016. - T. 8. - P. 474-479
9. Kelly M.D. Acute Mirizzi syndrome // Journal of the Society of Laparoendoscopic Surgeons. - 2014. - Vol. 13. - P. 104-109.
10. Kwon A-H., Inui H. Preoperative diagnosis and efficacy of laparoscopic procedures in the treatment of Mirizzi syndrome // J. Am. Coll. Surg. - 2014. - Vol. 204, 3. - P. 409-415.
11. Lai E.C.H., Lau W.Y. Mirizzi syndrome: history, present and future development // ANZ J. Surg. - 2013. - Vol.76. - P. 251-257.
12. 15. The Mirizzi Syndrome: multidisciplinary management promotes optimal outcomes/ R. Mithani, W.H. Schwesinger, J. Bingener et al. // J. Gastrointest. Surg. - 2014. - Vol.12. - P.1022-1028.
13. Combination of magnetic resonance cholangiopancreatography and computed tomography for preoperative diagnosis of the Mirizzi syndrome / E.J. Yun, C.S. Choi, D.Y. Yoon et al. // J. Comput. Assist. Tomogr. - 2015. - Vol. 33, 4. - P. 636-640
14. New diagnostic and surgical approach to Mirizzi syndrome / B. J. Sánchez, S. R. Cabezali, L. E. Monsalve [et al.] // An. Med. Interna. - 2007. - Vol. 24, 6. - P. 281-284.
15. Pedrosa, I. MR imaging in abdominal emergencies / I. Pedrosa, N. M. Rofsky // Radiol. Clin. N. Am. - 2014. - Vol. 41. - P. 1243-1273.
16. Yeh C.N. Laparoscopic treatment for Mirizzi syndrome / C.N. Yeh, Y.Y. Jan, M.F. Chen // Surg. Endosc. - 2014. - T. 17. - P. 1573-1578.

*Статья поступила в редакцию 06.10.2018 г.  
Статья рекомендована к публикации 09.10.2018 г.*

© D.A. Beregoenko, A.Yu. Gorova, 2018  
*Research supervisor*  
G.R. Adzhisaliyev

## THE MIRIZZI SYNDROME. SURGICAL TREATMENT

This article presents an analysis of The Mirizzi syndrome, as well as the causes, the classification. The method of surgical treatment of Mirizzi syndrome was investigated.

**Keywords:** The Mirizzi syndrome, diagnostics, symptoms, reasons, surgical treatment, complication.

*Received for edition on 06.10.2018  
Recommended for publication on 09.10.2018*

УДК: 617-089.844

© . . . , 2018  
студент© . . . , 2018  
студент*старший преподаватель кафедры топографической анатомии  
и оперативной хирургии**Медицинская академия имени С.И. Георгиевского  
ФГАОУ ВО "КФУ им. В.И. Вернадского"  
г. Симферополь, Россия*

5 .

10 .

• ( ) - , -

• - - - -

• - , , - -

• - - - -

• - - - -

I - <30%;

60%, ; II 30-60%, 1,5 III - 2 .

1) : , , .

2) ( ) - , ,

3) ,

4) -

5) - , , ,

93-97% . , -

V ), : ( IV,

[1].

4 6 . ,

- , - .



[13].

[Cohen M.]

1-2 ( ).

2-5

1,5-

6 - 8 5/0-6/0.

5-0.

[6,14].

(Lich-Gregoir), (Boari).

(Lich-Gregoir)

Y-

Lich-Gregoir 1/3

5-

2-3

2,5-3





8-10 [2,8,15].

1. // - 2015. - 12-8. - . 1417-1419;
2. . 2012; 3: 51-4.
3. Alberts VP, Idu MM, Legemate DA, Laguna Pes MP, Minnee RC, et al. (2014) Ureterovesical Anastomotic Techniques for kidney Transplantation: a systematic review and meta-analysis. *Transplant International: official journal of the European Society for Organ Transplantation* 27:593-605.
4. Castillo O.A., Zubieta R., Yañez R. Laparoscopic surgery of vesicoureteral reflux: An experience in 42 patients with the Lich-Gregoir extra vesical technique. *Actas Urol. Esp.* 2013; 37 (10): 630-3. 22.
5. Chung M.S., Han S.W., Jung H.J., Im Y.J., Han H.H., Na J.C., Hong C.H. Transvesicoscopic ureteral reimplantation in children with bilateral vesicoureteral reflux: surgical technique and results. *J. Laparosc. Adv. Surg. Tech. A.* 2012; 22 (3): 295-300.
6. Emons MI, Petzke F, Stamer UM, Meißner W, Koschwitz R, Erlenwein J. Current practice of acute pain management in children—a national follow-up survey in Germany. *Paediatr Anaesth.* 2016 Sep;26(9):883-90
7. Gago Martínez A, Escontrela Rodríguez B, Planas Roca A, Martínez Ruiz A. Intravenous Ibuprofen for Treatment of Post-Operative Pain: A Multicenter, Double Blind, Placebo-Controlled, Randomized Clinical Trial. *PLoS One.* 2016 May 6;11(5):e 154004.
8. He B, Mou L, Sharpe K, Swaminathan R, Hamdorf J, et al. (2014) Laparoscopic Kidney Transplant by Extra Peritoneal Approach: The Safe Transition From Laboratory to the Clinic. *American journal of transplantation: official journal of the American Society of Transplantation and the American Society of Transplant Surgeons* 14: 1931-1936.
9. Kayler L, Zendejas I, Molmenti E, Chordia P, Schain D, et al. (2012) Kidney transplant ureteroneocystostomy: comparison of full-thickness vs. Lich-Gregoir techniques. *Clinical transplantation* 26:372-380.
10. Lamb KE, Lodhi S, Meier-Kriesche HU (2011) Long-term Renal Allograft Survival in the United States: a critical reappraisal. *American journal of transplantation: official journal of the American Society of Transplantation and the American Society of Transplant Surgeons* 11:450-462.
11. Le May S, Ali S, Khadra C, Drendel AL, Trottier ED, Gouin S, Poonai N. Pain Management of Pediatric Musculoskeletal Injury in the Emergency Department: A Systematic Review. *Pain Res Manag.* 2016; Apr 11. doi: 10.1155/2016/4809394

12. Lee S, Moon HH, Kim TS, Roh Y, Song S, et al. (2013) Presence of vesicoureteral reflux in the graft kidney does not adversely affect long-term graft outcome in kidney transplant recipients. *Transplantation proceedings* 45:2984-2987.

13. Marchini G.S., Hong Y.K., Minnillo B.J., Diamond D.A., Houck C.S., Meier P.M. et al. Robotic assisted laparoscopic ureteral reimplantation in children: case matched comparative study with open surgical approach. *J. Urol.* 2011; 185 (5): 1870-5.

14. Margreiter M, Gyori GP, Bohmig GA, Trubel S, Muhlbacher F, et al. (2013) Value of routine voiding cystourethrography after renal transplantation. *American journal of transplantation: official journal of the American Society of Transplantation and the American Society of Transplant Surgeons* 13:130-135.

15. Raffaelli G, Orenti A, Gambino M, Peves Rios W, Bosis S, Bianchini S, Tagliabue C, Esposito S. Fever and Pain Management in Childhood: Healthcare Providers' and Parents' Adherence to Current Recommendations. *Int J Environ Res Public Health.* 2016 May 13;13(5). pii: E499.

*Статья поступила в редакцию 10.10.2018 г.*

*Статья рекомендована к публикации 13.10.2018 г.*

© D.A. Beregovenko, M.S. Mikhailchuk, 2018

*Research supervisor*

**G.R. Adzhisaliyev**

## **SURGICAL TREATMENT OF MEGAURETER**

In article the causes of a megaureter are established and his classification is given. Methods of surgical treatment of a megaureter were investigated.

**Keywords:** Megaureter, classification, reason, diagnostics, surgical treatment.

*Received for edition on 10.10.2018*

*Recommended for publication on 13.10.2018*





Рис. 1. × 40

" " , " " 1 , -  
" " ( 2). " -  
" 2 , -

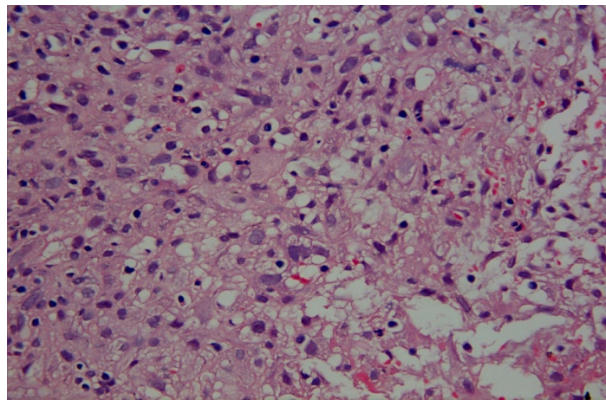

Рис. 2. ×4

2016  
26% -  
89% .  
[1].  
E6 E7.  
[2]

1. . . . / . . . . , . . . . , . . . . , . . . . . - 2016, - .3 - 1 - .66-78 // . . . . .
2. . . . : . . . . / . . . . , . . . . . - : . . . . , 2011. - 640 .

*Статья поступила в редакцию 26.10.2018 г.  
Статья рекомендована к публикации 28.10.2018 г.*

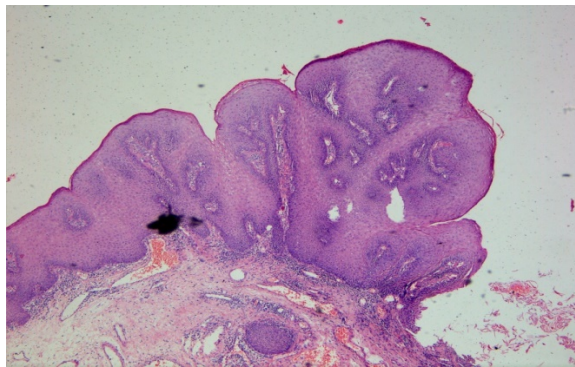
© N.L. Zverko, V.R. Askarova, 2018  
*Research supervisor*  
E.A. Anfinogenova

### ROLE OF HUMAN PAPILLOMAVIRUS IN THE DEVELOPMENT OF SQUAMOUS CELL LARYNGEAL CANCER

This article describes the morphological picture of precancerous diseases of the larynx, associated with lesion of the epithelium by human papillomavirus.

**Keywords:** human papillomavirus, precancer, larynx.

*Received for edition on 26.10.2018  
Recommended for publication on 28.10.2018*

10 (14) / 2018

*Экспертный совет*

... ( );  
Radek Novák, Mgr at; ... ;  
... ; ... ;  
... ; ... ;  
... ; ... ;

( ).

, , ,

---

77-70990 07 2017 .

( )

©  
"

", 2018

- . . .

28.10.2018 .

60 84/8. . . 9,75.

: 443093, . , . , 14

<http://www.nauka.org.ru/>; e-mail: zhurnalmr@bk.ru

.: 8-961-386-01-54

Scientific edition

**MODERN RESEARCHES**

**10 (14) / 2018**

*Editorial Board*

Yu.P. Grabozdin, Candidate of Economics (President of the Editorial Board)

Radek Novák, Mgr at Mgr; A.V. Azarkhin, Candidate of Economic Sciences;

A.A. Ermoshkin, Candidate of Engineering Sciences; Yu. Ivanov, Dr. of Economics, Associate Professor;  
N.V. Mingalev, Candidate of Economic Sciences; E.V. Fomenko, Candidate of Economic Sciences, Associate Professor;

A.D. Tsoi, Candidate of Engineering Sciences, Associate Professor;

M.V. Shingareva, Candidate of Pedagogic Sciences, Associate Professor

All articles are reviewed.

The editorial point of view does not always coincide with the point of view of the authors of the articles published.

The authors of the published articles are responsible for the accuracy of quotes, names, titles and other data,  
and also for compliance with laws about intellectual property

When using and borrowing materials reference to the publication is required.

---

The certificate of mass media registration EL FS77-70990 of September 7, 2017  
by Federal Service of Supervision in the sphere  
of Mass Media and Protection of Cultural Heritage  
© Limited Liability Company  
"Center of Scientific Researches and Consulting"

Approved for publication on Web site 28.10.2018.  
Format 60 84/8. Printed signatures 9,75.

Editorial and publishing address: 14, Myagi str., Samara, 443093, Russia  
<http://www.nauka.org.ru/>; e-mail: [zhurnalmr@bk.ru](mailto:zhurnalmr@bk.ru)  
Phone: 8-961-386-01-54